

SIDE VIEW

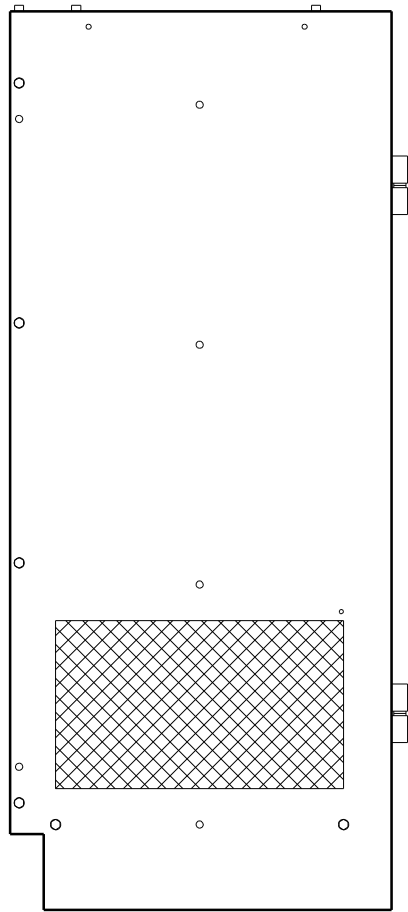

FRONT VIEW

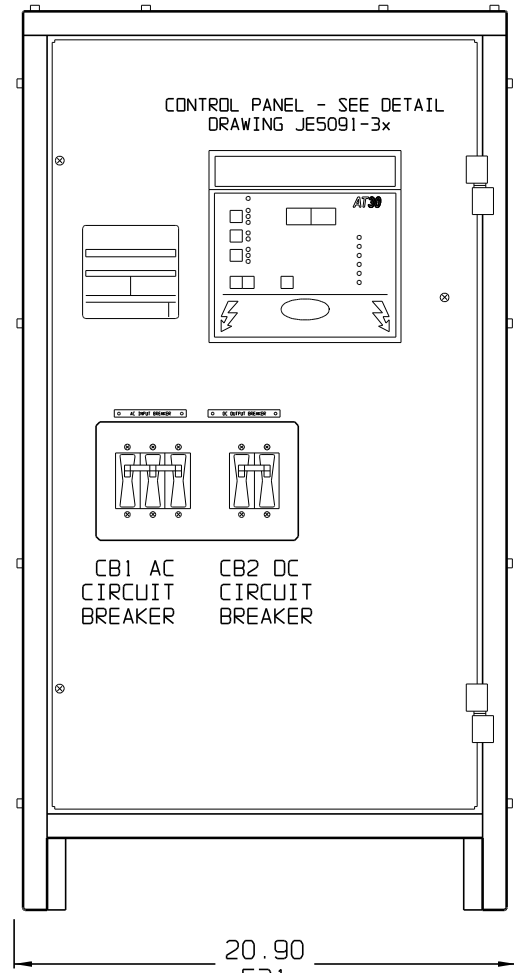

SIDE VIEW

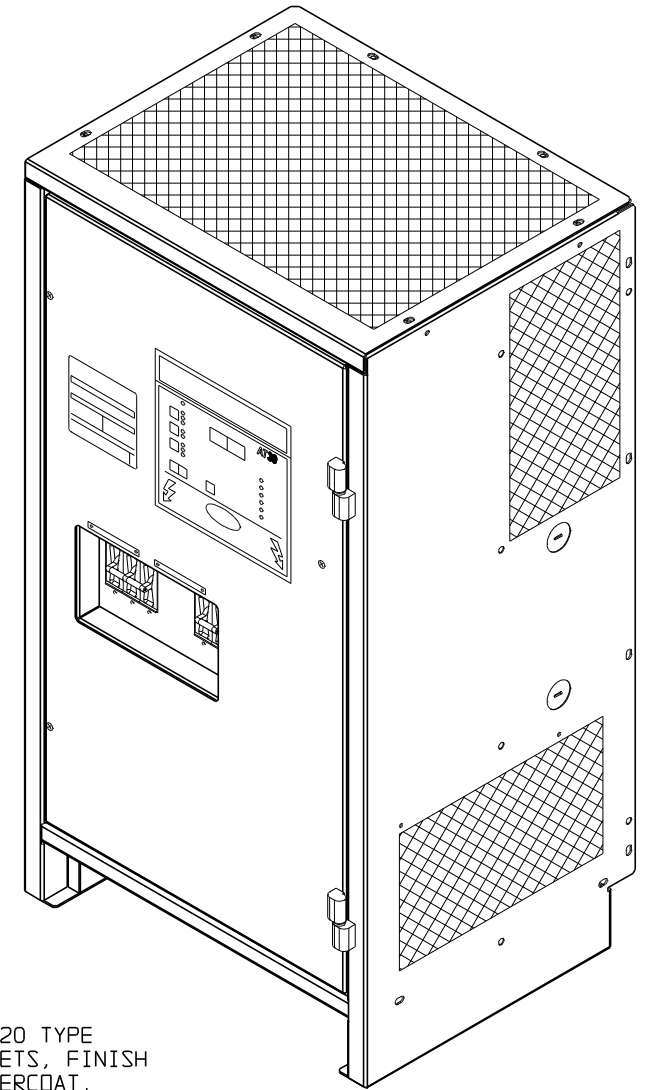
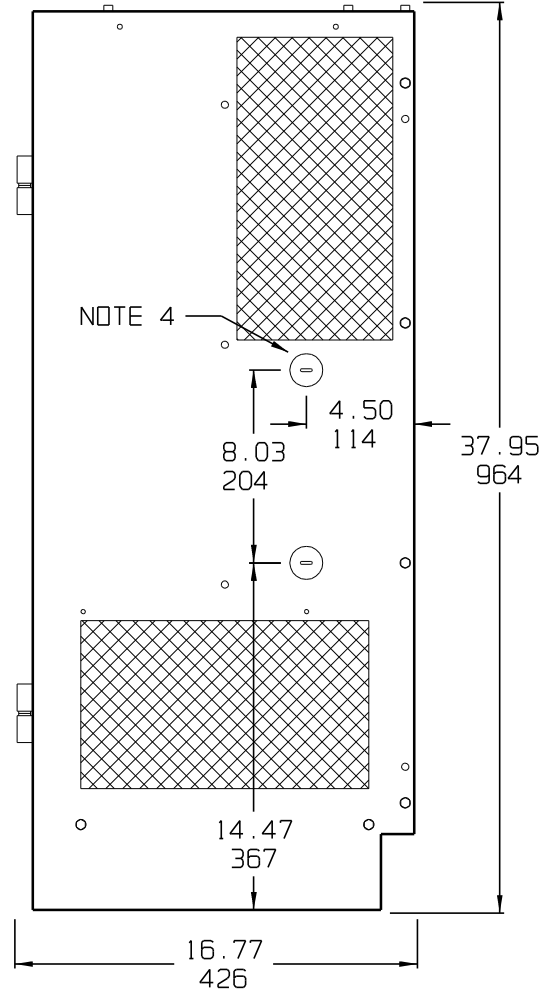

NOTES:

- 1) ENCLOSURE IS A NEMA-1 / IP20 TYPE STEEL CABINET WITHOUT GASKETS, FINISH IS ANSI-61 GRAY EPOXY POWDERCOAT.
- 2) ALLOW 12in / 305mm OF FREE AIR (TOP AND FRONT OF CABINET) FOR VENTILATION.
- 3) FOUR (4) 1in x 0.625in / 25mm x 16mm FLOOR-MOUNTING SLOTS ARE PROVIDED ON BOTTOM OF ENCLOSURE AS SHOWN.
- 4) TWO (2) 1.31in / 33mm DIA STANDARD PRE-FAB KEY-SLOT KNOCKOUTS ARE PROVIDED AS SHOWN FOR 1in / 25mm CONDUIT ENTRY. IF ADDITIONAL CONDUIT ENTRANCES ARE REQUIRED, ENCLOSURE SHOULD BE FIELD-MODIFIED BY INSTALLER.
- 5) BATTERY CHARGER SHIPPING WEIGHT: (SEE PRODUCT LITERATURE)

BOTTOM VIEW

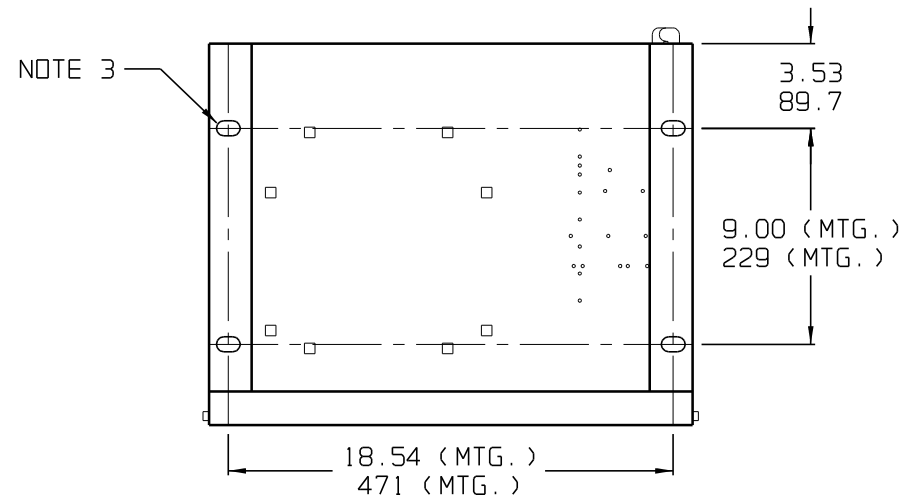

DUAL DIMENSIONS in mm

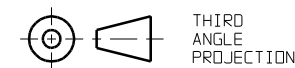

DRAWN BY MCR		092506				1075 Saint John Street Easton, PA 18042-6661 PH 610-330-9000 FAX 610-330-8510 www.hindlepowerinc.com			
APPROVED				TITLE AT30 SERIES BATTERY CHARGER OUTLINE: NEMA-1 STYLE-5018 ENCLOSURE					
0		20343		092506		DRAWING No JE5085-00		REV 0	B
SCALE	NTS	PART No	JE5085-00		SHEET	1 OF 1			

REV	ECN No	DATE	APP
0	20343	092506	

UNLESS OTHERWISE NOTED DIMENSIONS ARE IN INCHES. TOLERANCES ARE: